

Refrigerated Centrifuge 15000 rpm



AHN myLab RC-01



Instruction Manual

CONTENTS

1. INTRODUCTION	1
2. INTENDED USE	1
3. SYMBOL	1
4. FEATURES	1
5. STANDARD ACCESSORIES	1
6. TECHNICAL SPECIFICATIONS	2
7. SAFETY PRECAUTIONS	3
8. INSTALLATION	4
9. STANDARD PARTS LISTING	5
10. USER INTERFACE AND DISPLAY	6
11. ROTOR INSTALLATION	8
12. OPERATING THE CENTRIFUGE	10
13. REMOTE OPERATION & PROGRAMMING	10
14. MAINTENANCE AND CLEANING	15
15. TROUBLESHOOTING	16
16. WARRANTY STATEMENT	18
17. PRODUCT DISPOSAL	18
18. TRANSPORTATION & STORAGE	19

1. INTRODUCTION



This manual provides important safety information for this centrifuge. It should be kept near the centrifuge for quick & easy reference. This centrifuge is equipped with maintenance free brushless DC motor drive with microprocessor controlled that can speed up to 15,000 RPM and a safety feature of imbalance detection. This centrifuge is equipped with refrigeration which can be maintained as low as up to -20°C up to 40°C.

2. INTENDED USE

This centrifuge is designed to separate, sediment, spin down aqueous solutions & solvent suspensions of differing densities in compatible sample containers.

NOTE: Before using the centrifuge, please read this user manual carefully. This user manual is intended to assist with the operation and care of the unit & is not a document which aids in repair. For repair please contact the supplier.

3. SYMBOL

 Warning	 Waste electrical
 Fuse	

4. FEATURES

- Maximum volume of 44 x 1.5/2 ml*
- Temperature ranges from -20°C to 40°C
- Temperature of 4 °C maintained even at high speed
- Imbalance detector with auto cutoff for safe operation
- Brushless DC motor for maintenance free performance
- Large LCD display with speed and time indicator
- Speed setting from 500-15000 RPM
- One press changeover from RPM to RCF functionality
- Digital countdown Timer
- Reduction adaptors for 0.1/0.2 & 0.5ml tubes
- Emergency lid release during power failure
- Automatic internal diagnosis & error display
- Silent operation

(*Available with 4 optional rotors)

5. STANDARD ACCESSORIES

- T - Allen wrench

5. STANDARD ACCESSORIES

- Adaptors for 0.4/0.5 ml tubes
- Adaptors for 0.1/0.2 ml tubes
- Product user manual and warranty card
- Power cord
- Grease Tube

NOTE: Rotors has to be ordered separately. (optional accessory)

6. TECHNICAL SPECIFICATIONS

Motor Type	Brushless DC Motor
Rotor Capacity	24 x 1.5/2ml tube, 44 x 1.5/2ml tube, 8 x 4 x 0.1/0.2ml PCR tube/strips, 8 x 5ml tube
Speed Setting	Variable 500 - 15000 RPM
	22388 x g (Max RCF)*
Speed Step	± 100 RPM
Speed Accuracy	± 100 RPM
Temperature Accuracy	± 1 °C
Temperature Range	-20°C to 40°C.
Run Time	30s to 999min & 59s
Acceleration Time	< 72 seconds
Deceleration Time	< 74 seconds
Noise Level	<60 dB
Ambient Temperature	≤80%
Permissible Relative Humidity	20 to 80%
Size (W x D x H)	325 x 720 x 305 mm
Weight	43 kgs
Refrigerant	R134a
Total mass of Refrigerant	251 g
Maximum allowable pressure (PS) under normal condition	250 psi
Altitude	Use upto an altitude of 2000 m above MSL

6. TECHNICAL SPECIFICATIONS

Pollution Degree	2
Environment	For indoor use only
Power Supply	230 VAC, 50Hz
Power Consumption	650W
Safety Fuse Rating	10Amp

(* RCF varies for each rotor congregation - As mentioned in point no 11 (rotor Installation).

7. SAFETY PRECAUTIONS



Read all safety & usage information provided in this manual carefully before using the device.

- Never use the centrifuge in any manner not specified in this manual.
- Using equipment in any manner not specified in this manual or by the manufacturer, will void the warranty.
- Never move the centrifuge while the rotor is spinning.
- The rotor and the rotor lid must always be securely fastened. If the centrifuge makes unusual noise during operation, the rotor or rotor lid fit needs to be checked. Switch OFF the device immediately by pressing STOP, check rotor fit & fasten it well.
- The rotors must be loaded symmetrically. Each tube should be counter balanced by another tube of the same weight.
- Do not use the centrifuge or rotor that have not been correctly installed or damaged.
- Repairs must only be performed by authorized service technician.
- Using incorrect rotors & wrong spare parts will void the warranty.
- Centrifuge may be used for the specified applications only. It must not be operated in a hazardous or flammable environment and must not be used to centrifuge explosive or highly reactive substances.
- If liquids are spilled on the rotor or rotor chamber, the centrifuge must be cleaned carefully and properly before being used again.
- Prior to centrifugation, the tubes should be visually inspected for material damage. Damaged tubes may not be centrifuged. This is because broken tubes can, in addition to sample loss, create imbalance which can result in further damage to the centrifuge and accessories.
- The maximum capacity of tubes must not be exceed its corresponding rotor capacity. Do not use liquid with density higher than 1.2g/ml for full load operation.

7. SAFETY PRECAUTIONS

- Do not lean on the equipment. It may damage the equipment or harm the operator.
- When moving the centrifuge from a cold room to a normal room, run the centrifuge for 30 minutes beforehand in the cold room to avoid condensation. Alternately, allow it to warm up in the lab for at least 3 hours before use, but do not plug in the centrifuge in order to prevent possible damage by condensation.
- Be sure to close the tubes lid tightly prior to centrifugation. Open tubes lid can be torn off during centrifugation and can damage the rotor lid or centrifuge.
- Rotors and rotor lids are high-graded components which are subject to extreme mechanical strain. Even slight scratches and tears can lead to serious internal material damage. Ensure to check the rotor for any signs of damage before use. Rotor & rotor lid showing visible signs of corrosion or mechanical damage should not be used, contact your local supplier or mfg for replacement rotor & parts.
- Do not fill tubes while they are in the rotor. Liquid spillage may harm the device.
- In the event of contamination caused by aggressive agents, the rotor must be cleaned immediately using a natural cleaning liquid (like water). This is particularly important for the bores of the tubes. If any damage is seen, contact the service technician.
- Before using cleaning or decontamination methods, other than those stipulated by the manufacturer, contact the manufacturer to ensure that the intended method will not damage the centrifuge.
- The power cord given with centrifuge unit is designed to use for that particular centrifuge. Do not use any other power cord, using any other power cord /adaptor may damage the centrifuge and will void the warranty.
- Safety Fuse is provided of 10Amp configuration which can be replaced by the operator. The same will protect the machine circuit during an electrical fault or overload.

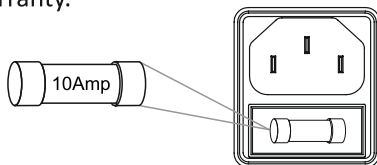

8. INSTALLATION

Open the box, then remove the packaging and gently take the centrifuge out of the box. Before using this centrifuge open the centrifuge & remove all packaging from the rotor chamber & ensure rotor is firmly tightened. The user manual and accessories should be kept near the centrifuge. Please keep all packaging in safe storage for at least 2 years for warranty purpose.

MOUNTING

Place the centrifuge on a flat and leveled surface, ensure that the four feet of this centrifuge stand on the surface firmly. Avoid installing on a slippery surface or surface

8. INSTALLATION

prone to vibration.

1. Ideal ambient temperature is $20^{\circ}\text{C} \pm 5^{\circ}\text{C}$, avoid placing the centrifuge in direct sunlight.
2. Keep clearance of at least 30-35 cm on both sides and at least 20 cm behind it to guarantee cooling efficiency.
3. Keep away from heat or water to avoid sample temperature issues or centrifuge failures.
4. Do not place the centrifuge in any area where operating the unit maybe difficult.

CONNECTING POWER CORD

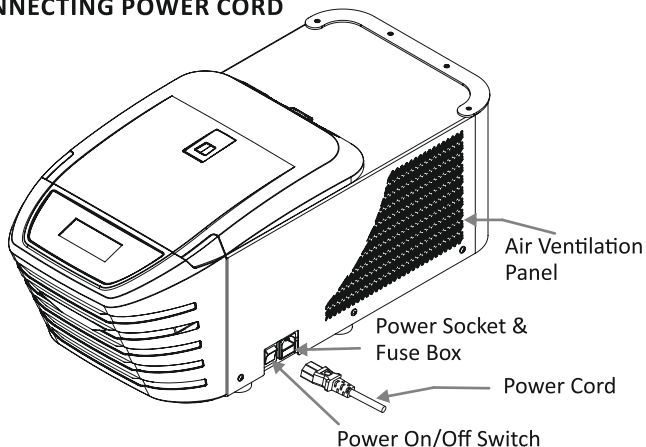

Connect one side of power cord to rear side of centrifuge and other to supply as shown in the figure below.

9. STANDARD PARTS LISTING

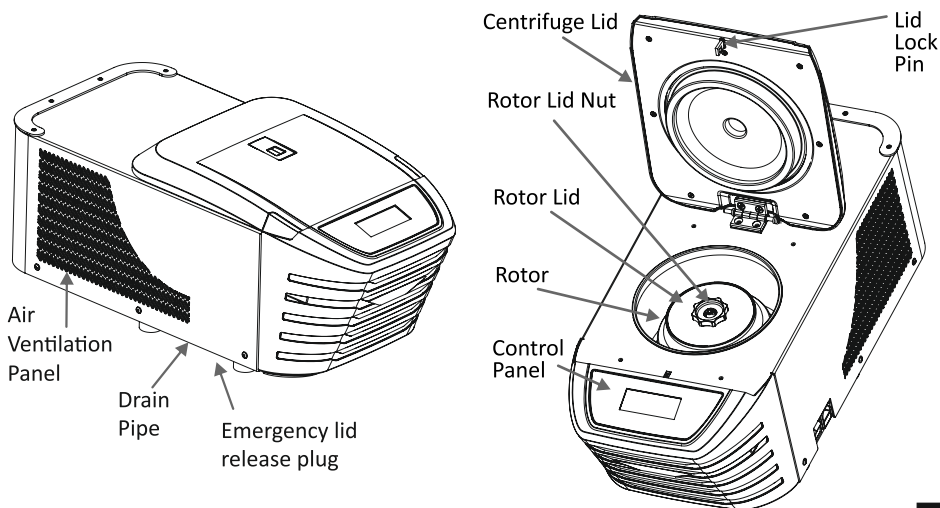

10. USER INTERFACE & DISPLAY

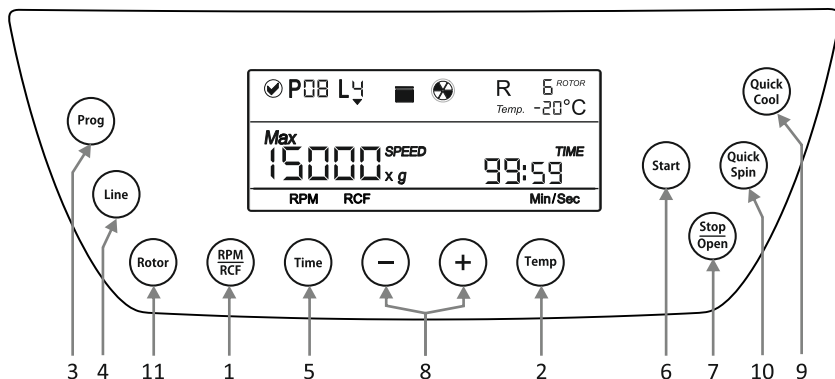

Item	Name	Function
1	RPM/RCF	Press button to select SPEED value in rpm mode. And press +/- key to set desired run RPM. Press and Hold to switch to RCF mode. Press +/- key to set desired RCF.
2	TEMP	Press button to set the temperature value in a range from 4°C to 40°C. And press +/- key to set desired temperature.
3	PROG	Press button to enter in Program Mode and to select any Program out of the 99 available programs.
4	LINE	Press button to select line of any specific program out of 4 available lines in each program.
5	TIME	Press button to select TIME mode. And press +/- key to set desired run TIME.
6	START	Press button to START to start the centrifuge.
7	STOP/OPEN	Single press Stop/Open button, will stop motor. Second press Stop/Open button, will open the lid once the motor stop. Also used for lid open if centrifuge motor is not running.
8	+/- Keys	Use to set speed, Temperature and time values. Press "+" to increase and "-" to decrease values.
9	QUICK COOL	To start a temperature control run at optimized (5000)RPM to achieve maximum cooling

10. USER INTERFACE & DISPLAY

10	QUICK SPIN	To set short spin on a set speed. Press short spin continues press for Quick spin operation.
11	ROTOR	To select among multiple rotor listed below.

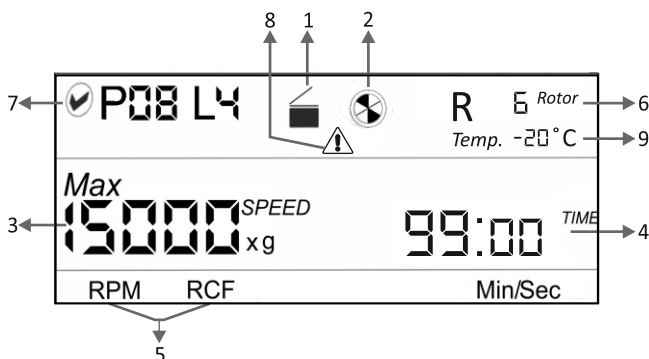











Item	Symbol	Description
1		Indicates lid status. Left image = lid close and Right image = lid open.
2		Indicates centrifuge status. When centrifuge is running the symbol rotates and when centrifuge is not running the symbol is static.
3		RPM indicates the speed value at which centrifuge is running. Xg indicates the value in RCF mode.
4		Countdown timer. Indicates the time for which the centrifuge will run. Indicates the time in Min/Sec mode.
5	RPM / RCF	Indicates rpm or RCF mode and shows corresponding values.
6	R 008 <i>Rotor</i>	Indicates selected rotor.
7	P08 L4	Indicates selected program number and the line number specific to that program.
8		Warning symbol. It appear when some error occur.
9	-20°C	Chamber temperature indication.

11. ROTOR INSTALLATION

ROTORS AND ACCESSORIES

The table below shows rotors compatible with the centrifuge and the Max. RCF with different tubes and adaptors.

<u>24 X 2ml rotor</u> (standard supply)	1.5/2.0ml tubes	0.5ml Adaptor	0.1/0.2ml Adaptor		<u>PCR strip rotor</u> (Optional)	0.2ml PCR strip
						
			0.1ml	0.2ml		
Max. Speed	15000	15000	15000	15000	Max. Speed	15000
Max. RCF x g	21420	18842	16103	16930	Max. RCF x g	15397

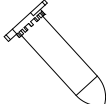
<u>44 X 2ml rotor</u> (Optional)	1.5/2.0ml tubes	0.5ml Adaptor	0.1/0.2ml Adaptor		<u>8 X 5ml rotor</u> (Optional)	5ml tube
						
			0.1ml	0.2ml		
Max. Speed	15000	15000	15000	15000	Max. Speed	15000
Max. RCF x g	22388	19810	17070	17898	Max. RCF x g	18461

NOTE: Always use recommended accessories for best results and product safety. Optional rotors & additional accessories must be ordered separately.

ROTOR REMOVAL AND REPLACEMENT PROCESS

The rotor comes pre-installed with the centrifuge. If you want to remove or replace the rotor, follow the instructions below.

REMOVING THE ROTOR

1. Do not remove or loosen the rotor lid before attempting to remove the rotor.
2. Using the T - Allen Key, loosen the rotor nut by turning it counter clockwise. Do not try to pull the rotor, the rotor will come up automatically.
3. Once the rotor nut is loosen completely, pull up the rotor vertically.

REPLACING THE ROTOR

1. To replace or install the rotor, take the rotor and load vertically onto the shaft.
2. Place the rotor nut in the center hole of the rotor onto the motor shaft.

11. ROTOR INSTALLATION

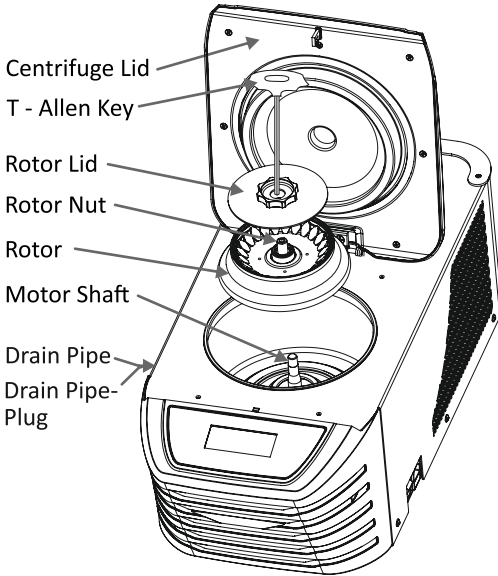

3. Put T-Allen Key into the rotor nut and turn clockwise to tighten and counter clockwise to loosen the rotor.
4. After properly fastening the rotor, place the rotor lid on the rotor lid nut by hand and rotate the rotor lid nut clockwise.

NOTE:

- 1) Check the rotor is firmly tightened before running the next program.
- 2) Do not remove or loosen the rotor lid before removing the rotor.

BALANCING THE ROTOR

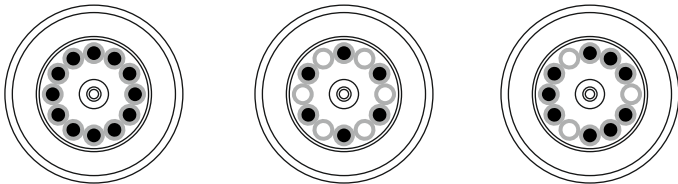

1. Always balance the rotor before centrifugation. Above are examples of properly balanced rotors.
2. The samples in the tubes should be of equal volume.
3. If the tubes are not loaded correctly - vibration or imbalance can occur which can cause serious damage to the centrifuge.
4. If the tubes are not loaded symmetrically then the imbalance detector will cut off the running centrifuge for device & user safety. This will stop the centrifuge and Err 55 will be seen indicating tubes are not loaded symmetrically. To resume operation, load tubes symmetrically & restart the centrifuge.
5. Incorrect method of loading tubes in centrifuge rotor :

11. ROTOR INSTALLATION

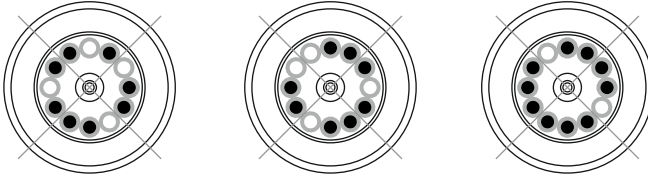

12. OPERATING THE CENTRIFUGE

STARTING THE CENTRIFUGE

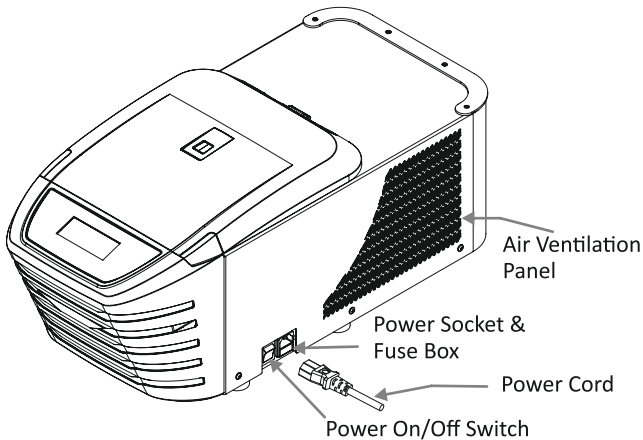

After connecting the power cord, switch ON the power at the rear side of the centrifuge. Make sure to check the rotor fit before use. Centrifuge will not operate with an open lid.

NOTE: Maintain a gap of 3 seconds between turning off and turning on the centrifuge. DO NOT turn off and turn on the centrifuge instantly.

13. REMOTE OPERATION & PROGRAMMING

SWITCH ON THE CENTRIFUGE

After connecting the power cord. Switch ON the main power supply & then Switch on

13. REMOTE OPERATION & PROGRAMMING

the power switch located on the right side of the instrument. Make sure to check the rotor fitment before use. Centrifuge will not operate with open lid.

NOTE: *Maintain a gap of 3 seconds between switch OFF and switch ON again. DO NOT switch OFF and ON again instantly.*

SPEED SETTING

After closing the centrifuge lid, press “RPM / RCF” to select speed setting in RPM / RCF mode. Press “+” to increase the speed value and press “-” to decrease the speed value. The minimum and maximum speed (RPM) of the centrifuge is 500 rpm and 15000 rpm respectively. You can quickly change the increment / decrement value by rotating setting knob quickly. Value is accepted when left idle indicated by multiple blinks of the set value.

The speed can also be changed while the centrifuge is under operation. Press the RPM / RCF button & use setting knob to change speed as instructed above. Changing the speed between the ongoing centrifugation will run the centrifuge at updated speed for the remaining time indicated by the timer.

TIMER SETTING

Press “TIME” button to set the run time. After selecting press “+” to increase the timer value and press “-” to decrease the timer value. Value is accepted when left idle indicated by multiple blinks of the set value. The centrifuge timer can be set from 30s to 999mins and 59s. The timer in the centrifuge is countdown timer and time in the display will be in “Min/Sec”. The same will showed on the display.

1. To set the timer in minutes, pressing the time button “ONCE”. For example: if time is 005:00 (5 Mins 0 Sec), then next time will be 006:00 (6 Mins 0 Sec).
2. To set the timer in seconds, pressing the time button “TWICE”. For example: if time is 005:00 (5 Mins 0 Sec), then next time will be 005:01 (5 Mins 1 Sec).
3. Pressing time button more than 2 times will start the process from point 1 again.
4. The input will be accepted if we leave the setting knob idle for 3 seconds. The value be saved automatically after five blinks.

TEMPERATURE SETTING

Press temperature button for setting the temperature from -20°C up to 40 °C. The parameters can be set when the Temperature value blinks by pressing “+” key for increasing the temperature & “-” to reduce the temperature. The values will automatically saves after screen stops blinking.

QUICK COOL SETTING

PRESS Quick Cool Key, indicated by (cubic rotation) on top right (Indication will be in

13. REMOTE OPERATION & PROGRAMMING

dotted rotation in place of rotor digit indication). During quick cool operation rpm:- FIX 5000 & TEMP:-On set value. Press START button for centrifuge to start at FIX RPM & set TEMP. After reaching set TEMP, motor stops thus RPM becomes zero but compressor continues to keep the chamber temperature at the set value. The quick cool works for 1 hour only. (for indication of refrigeration running process, TEMP display will blink) If timers stops and TEMP does not reach to set value, TIME will switch-over from beginning. “RPM/RCF, Timer, Rotor, Line, Prog”, “Quick Spin” button not work during “Quick Cool” operation.

SHORT SPIN OPERATION

Short Spin Centrifugation is the feature for short/pulse/quick run. It will run as long as the button is pressed. Set rotational speed prior to short spin as required. During short spin the timer will be in incremental mode. After releasing short spin button the time in the display will show duration of short spin.

ROTOR SELECTION

Different rotors has different radius which means that RCF for that rotor would also be different. Proper selection of rotor is mandatory to achieve proper RCF. Press “Rotor” button and then rotate setting knob to select the rotor from available 4 rotors. Press “Rotor” button . See below chart to identify rotor no. from its volume:

Rotors			
Rotor No.	Name	rpm	RCF at max rpm
1	24 slot x 2ml rotor	15000	21420 g
2	4 x 8 PCR rotor	15000	15397 g
3	8 slot x 5 ml rotor	15000	18461 g
4	44 slot x 2ml rotor	15000	22388 g

Press "+" & "-" button to change the value/no of rotor to set that rotor no or value will be stored automatically if no button is pressed after 6 seconds of the adjustment. Then so the max value of speed and acc/dcc to be changed as per the rotor selection. (Max. Speed (RPM/RCF) and Acc/Dcc vaule for all the rotors have been added in the software) Now set the desired speed (RPM/RCF), time & temp and press START button to store and run the selection.

START AND STOP OPERATION

Press “START BUTTON” to start operation and press “STOP/OPEN BUTTON” to stop the ongoing operation. When the centrifuge is running the symbol “⊗” will rotate.

13. REMOTE OPERATION & PROGRAMMING

Pressing the “STOP/OPEN BUTTON” will stop the operation. Once operation is stopped, press Button again to open the centrifuge lid. If the time gets over, centrifuge will stop automatically. When the centrifuge is not running the symbol “⊗” will be idle. To open the lid in non-operating stage, press the “STOP/OPEN BUTTON”.

After completing run, before any another operation, it is mandatory to open the lid once before starting new operation. Centrifuge will not do 2nd operation if lid is not opened and closed for at least one time after completion of 1st operation.

NOTE: It is mandatory to open the lid once after completion of operation for 2nd operation. Centrifuge will not start if lid is not opened and closed after completion of a operation.

PROGRAM MODE

Long press “PROG” button to enter into program mode. Short press select program and rotate setting knob (clockwise & anticlockwise) to select desire program out of 99 available programs. User can select any program from 1 to 99 programs and can have user specific setting parameter for all programs. Each program has 4 lines indicated by L1, L2, L3, L4. Press “LINE” button to enter in line selection mode and rotate setting knob to select line out of 4 lines.

Every line of the program can have different values for all setting parameters. User can set and save different speed, different time, different temperature for any line of program. Only Rotor will not remain save for any program. Rotor selection is not Program specific. Rotor selection is universal and it should be set before setting any other parameters.

On first time usage, all programs will have zero (0) values and once the “PROG” button is pressed below display will appear indicating selection of program mode.

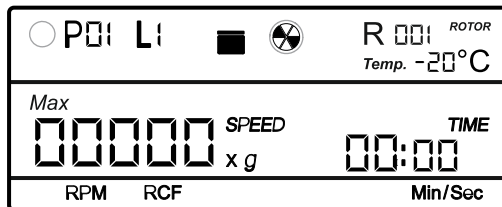

As per above image, the circle O left of “P01 L1” is blank indicating no values in any line of specific program. Once any line of Program in filled or set, below change of display will appear.

13. REMOTE OPERATION & PROGRAMMING

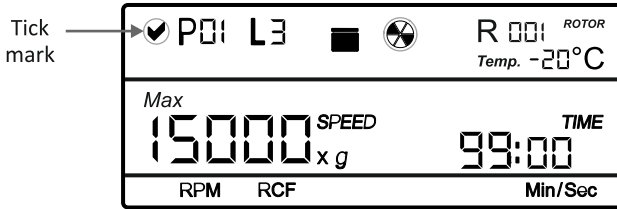

The circle ☑ left to “P01 L3” will have a tick mark indicating that any one line of the specific program is filled. If any line leading to selected line is set, then the arrow below the line number will appear.

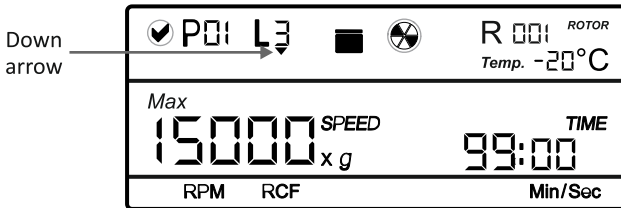

If no leading line is filled or last line L4 is selected then the arrow below Line will not appear. It indicates there is no further operation left as leading lines of the specific program are empty.

program and selected rotor remains active for all programs until new rotor number is not selected. Select the rotor, Press “PROG” button to enter in Program mode, select specific program using setting knob, Press “LINE” button to select specific line and set different parameter for that particular line of program. Values for any parameter gets save after 3 blinks. Once Program is set, press “START” button to start program.

After completion of any operation, it is mandatory to open the lid at least once for another operation. Open the lid, close it again and press START for another operation.

NOTE:

- 1) Rotor is not program specific. Selected rotor will be active for any new operation.
- 2) It is mandatory to open the lid once after completion of operation for 2nd operation. Centrifuge will not start if lid is not opened and closed after completion of ongoing operation.

IMBALANCE DETECTION

The centrifuge is equipped with an imbalance detection safety feature. When the rotor is not loaded symmetrically, the imbalance detector gets activated and will cut

13. REMOTE OPERATION & PROGRAMMING

off the centrifugation. The error "Err 55" will be shown on the display. First correct the imbalance load then switch OFF & switch it ON again. The values will be same as set before imbalance. The imbalance detection feature cannot be deactivated, as it is factory fitted.

OPENING CENTRIFUGE LID IN POWER FAILURE

Disconnect the centrifuge from the main power supply. Wait until the rotor has come to a standstill (this may take longer time). Once the rotor has stopped, Pull the Emergency Lid release lever by hand or by a small Allen Key located on the left side of the machine as show in image below. This will open the centrifuge lid.

NOTE: This method of opening the lid should be used only in case of Emergency or power failure.

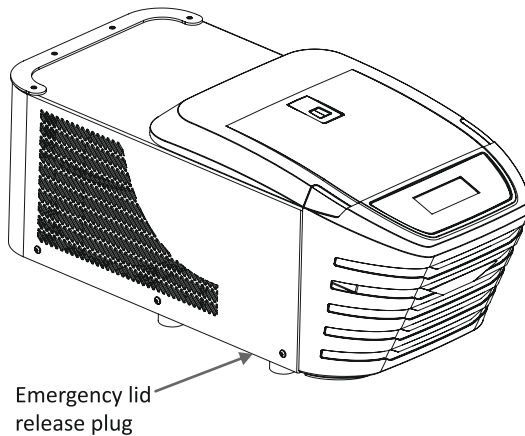

14. MAINTENANCE AND CLEANING

- The rotor and the outside of the centrifuge should be cleaned regularly with a mild wet (with water) cloth.
- Ensure that while cleaning the unit is not plugging in.
- Wear protective glove & safety glass while operating & cleaning the device.
- The brushless motor in the centrifuge requires no routine maintenance. Any required service should be performed by authorized, qualified personnel only. Repairs performed by unauthorized personnel may void the warranty.
- Always keep the centrifuge housing, rotor chamber and rotor clean. All parts should be wiped down periodically with a soft cloth. For more thorough cleaning, use a neutral cleaning agent (Ph between 6 and 8) and clean with a soft cloth. Exclusive amounts of liquid should be avoided.

NOTE: Liquid should not come into contact with the motor.

14. MAINTENANCE AND CLEANING

- After cleaning, ensure that all parts are dry before re-use.
- Regularly cleaning of the rotor is important.
- If the rotor chamber needs cleaning, clean with cloth or sponge moistened with a neutral detergent solution.
- Do not place the rotor into the cleaning solution.
- If corrosive, toxic or pathogenic bacteria are accidentally spilled in the rotor or rotor chamber the centrifuge must be decontaminated thoroughly.
- Grease tube has been provided as part of standard accessory. Minor Grease has to be applied on the Motor shaft (Threaded Parts, Grooves) at every 2 weeks interval to prevent rotor & shaft jam. This also would ease installation process in case of regular rotor change.

15. TROUBLESHOOTING

This centrifuge has a self – diagnostic function. If a problem occurs, an error/warning code will be displayed on the display screen and the operator can determine the malfunction with the warning code below.

ERROR	PROBLEM	SOLUTION
No display	No main power connection.	Power check & proper plug-in of main cable at both ends.
	Power failure.	Check the mains fuse.
	Improper connection.	Connect adaptor properly.
	Lid not closed correctly.	Close lid correctly and restart unit.
	Error with lid closing and opening mechanism.	Contact service.
Error 1	Latch jammed or any limit switch of latch got damaged.	Contact service representative.
Error 41	Selected temp value not reachable for selected set speed.	Set temp value will be taken automatically that it can be archived after 1 hour, Error indication will be displayed every 15 second. restart unit.
Error 42	Temperature is out of control.	Error indication will be displayed every 15 second. If it persists in every operation consistently, contact service representative. restart unit.

15. TROUBLESHOOTING

Error 43	Over temperature inside chamber.	Turn off the centrifuge and wait until temperature goes down. restart unit.
Error 44	Temperature sensor failure.	Contact service representative.
Error 52	Rotor stuck or incorrect operating voltage.	Turn off the centrifuge, check rotor fitment or apply correct 230 VAC \pm 10VAC operating voltage. restart unit
Error 55	Rotor not loaded symmetrically.	Load rotor symmetrically & restart centrifuge. restart unit.
Centrifuge lid cannot be opened.	Rotor is still spinning.	Wait for the rotor to come to a stop.
	Power Failure.	Emergency lid release after rotor stop.
Centrifuge shakes during acceleration & exceptional running noise.	Rotor not loaded symmetrically.	Load rotor symmetrically & restart operation.
	Either a broken tube, damage to the rotor or motor is cause for run noise.	Replace broken tube. For damaged rotor/motor contact service representative.
	Rotor damaged.	Remove & change rotor.
Display Error.	Loose connection of display.	Contact service representative.
Power tripping.	Cable not fit properly.	Remove cable and connect properly.
System gets hang.	Electronic error.	Switch OFF centrifuge and then switch it ON again. If the error still shows, contact service representative.

IMPORTANT NOTE

1. Maintain a 3 second gap between restarting the centrifuge. Instant ON-OFF can lead to a reset, erasing last run memory.
2. If the motor gets hot due to which there will be a fluctuation in speed value then allow the centrifuge to cool for atleast 30 minutes. Do not do any operation for 30 minutes.
3. Do not use liquids with density higher than 1.2g/ml for full load operation.

16. WARRANTY STATEMENT

This product is warranted to be free from defects in material and workmanship for a period of two (2) years from date of purchase. Your product will be duly repaired upon prompt notification in compliance with the following conditions :

This warranty is valid only if the product is used for its intended purpose and within the guidelines specified in this instruction manual. This warranty does not cover damage caused by accident, neglect, misuse, improper service, natural forces or other causes not arising from defects in original material or workmanship. This warranty does not cover any incidental or consequential damages, commercial loss or any other damages from the use of this product.

The warranty is invalidated by any non-factory modification, which will immediately terminate all liabilities on us for the products or damages caused by its use. The customer shall be responsible for the product or use of products as well as any supervision required for safety. If requested the products must be returned to the distributor in well packed and insured manner and all shipping charges must be paid.

NOTE: *Some states do not allow limitation on the length of implied warranties or the exclusion or limitation of incidental or consequential damages. This warranty gives you specific legal rights. This warranty is given expressly in lieu of all other warranties, expressed or implied.*

The purchaser agrees that there is no warranty of merchantability or of fitness for any intended purpose and there are no other remedies or warranties, implied, which extend beyond the description on the face of the agreement. This warranty is only applicable to the original purchaser.

Products received without proper authorization will not be processed for warranty or service. All items returned for service should be sent with postage prepaid in the original packaging or other suitable packaging, padded to avoid damage. We will not be responsible for damage incurred by improper packaging.

NOTE: *This warranty is valid only if the warranty is registered with the supplier within 30 days from the date of purchase.*

For your reference, make a note of serial number, date of purchase and supplier here.

Serial No.:

Purchase Date:

Supplier:

17. PRODUCT DISPOSAL

In case the product is to be disposed of, the relevant legal regulations are to be observed.

17. PRODUCT DISPOSAL

Information on the disposal of electrical and electronic devices in the European Community.

The disposal of electrical devices is regulated within the European Community by national regulations based on EU Directive 2012/19/EU on waste electrical and electronic equipment (WEEE). According to these regulations, any devices supplied after 13.06.05 in the business to business sphere, to which this product is assigned, may no longer be disposed off in municipal or domestic waste. They are marked with the following symbol to indicate this.

As disposal regulations within the EU may vary from country to country, please contact your supplier if necessary.



18. TRANSPORTATION & STORAGE

This device is heavy & weighs approximately 43kgs. Care must be taken while lifting up. Always take few people help to lift this instrument. The refrigerated centrifuge must be kept always in upright position while storing/transporting from place to place.

- Use only original packaging during transportation
- For longer distance take transportation aid like hard trucks
- Avoid knocking, harsh shaking or jolting the device
- Always retain the packaging material & transportation protections for longer storage or transportation
- The transportation conditions for the instrument is -25°C to 60°C with a Relative Humidity up to 80% & max pressure of 106kPa for both general & air transportation
- For storage the instrument is recommended to be stored in original package. the instrument is -5°C to 45°C with a Relative Humidity up to 70% & max pressure of 106kPa

ahn®

AHN Biotechnologie GmbH

Uthleber Weg 14
D-99734 Nordhausen
Germany

Phone: +49(0)3631/65242-0

Fax: +49(0)3631/65242-90

E-Mail: info@cappahn.com

www.ahn-bio.de

